



HOSHIZAKI

CERTIFICATION



HACCP International



ISO9001



Compliant with IEC60335-2-89 Standard

FT-186MC-S UNDERCOUNTER FREEZER



Key Features



Lower running cost

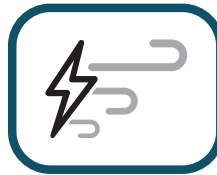

Powerful cooling performance

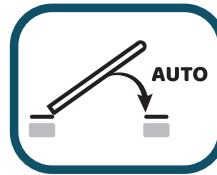

Self Closing Door



Removal door gaskets



Food Guard Shelf



Round Interior Corners



Large and clear display



Drainage-Free Design



LED lighting



Dimensions & Specifications

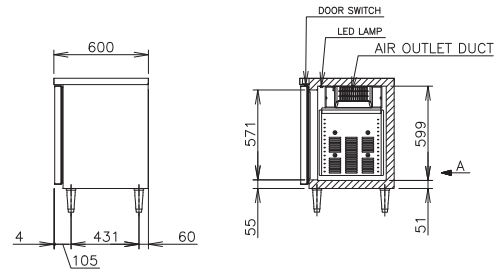
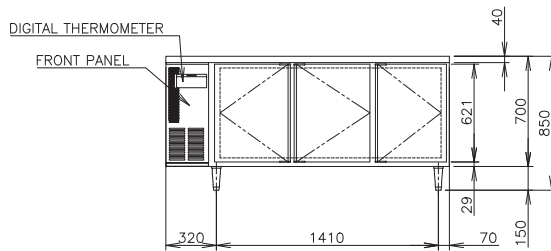
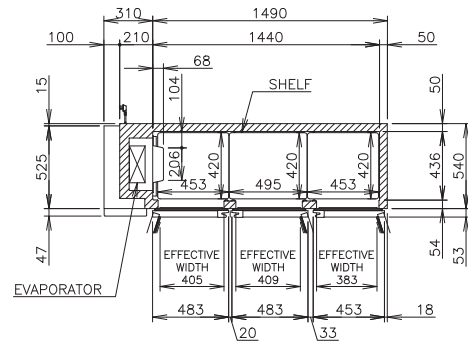
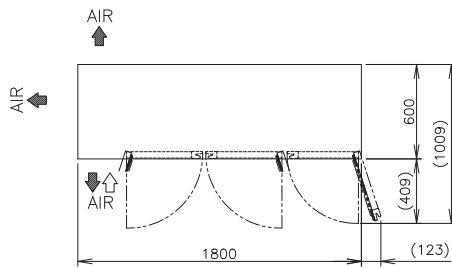
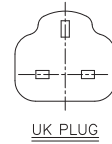
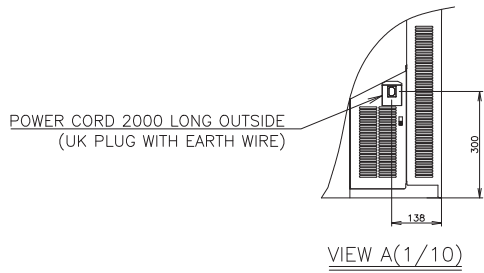

MODEL	FT-186MC-S
POWER SUPPLY	1 Phase 220-240V 50Hz Capacity: 0.75kVA (3.50A)
ELECTRIC CONSUMPTION	7.07kWh/day
TEMPERATURE CONTROL	-25 to -7°C
STORAGE CAPACITY	407L
WEIGHT	Net: 96kg (Gross: Approx. 108kg)
OUTSIDE DIMENSIONS	1800mm(W)× 600mm(D)×850(-880)mm(H)
PACKAGE	Carton: 1865mm(W)×680mm(D)×845mm(H)
NUMBER OF SHELVES	6pcs
REFRIGERANT	R290
OPERATING CONDITIONS	Ambient Temperature: 5 - 38°C, Voltage Range: Rated Voltage ±6%

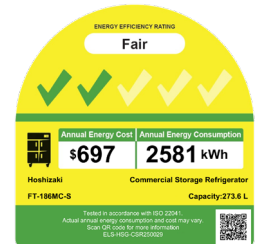

HOSHIZAKI

HOSHIZAKI SINGAPORE PTE. LTD.

18 Boon Lay Way #01-102 Tradehub21, 609966

TEL 6225 2612 FAX 6225 3219

www.hoshizaki.com.sg

