



HOOD TYPE DISHWASHER

HW-600B3



WASHING

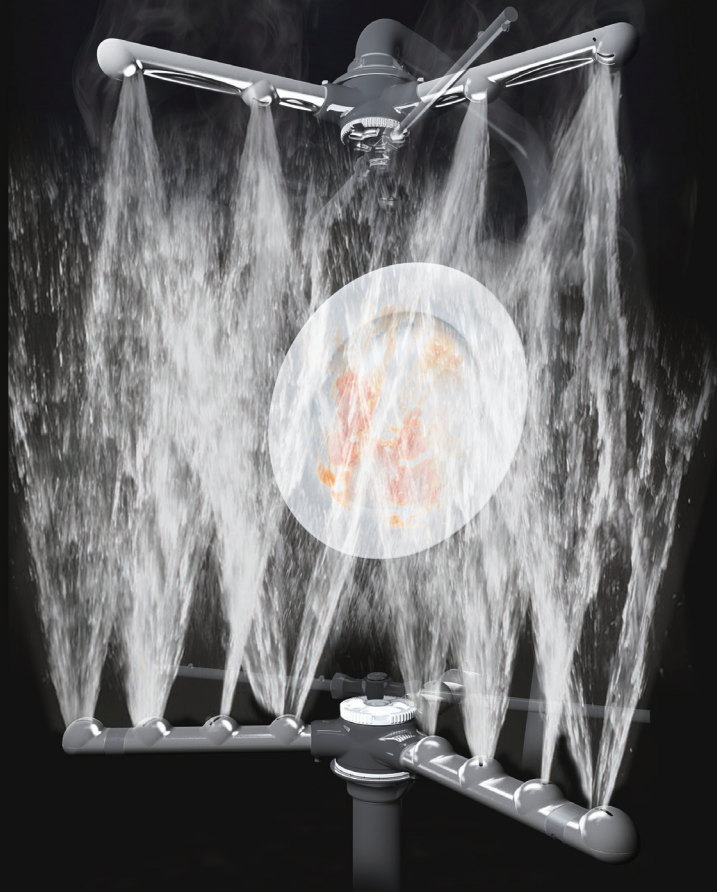

POWERFUL WASHING

Japan designed original triple arm nozzles enable three washing per rotation and clean up every corner powerfully and perfectly.

RINSING

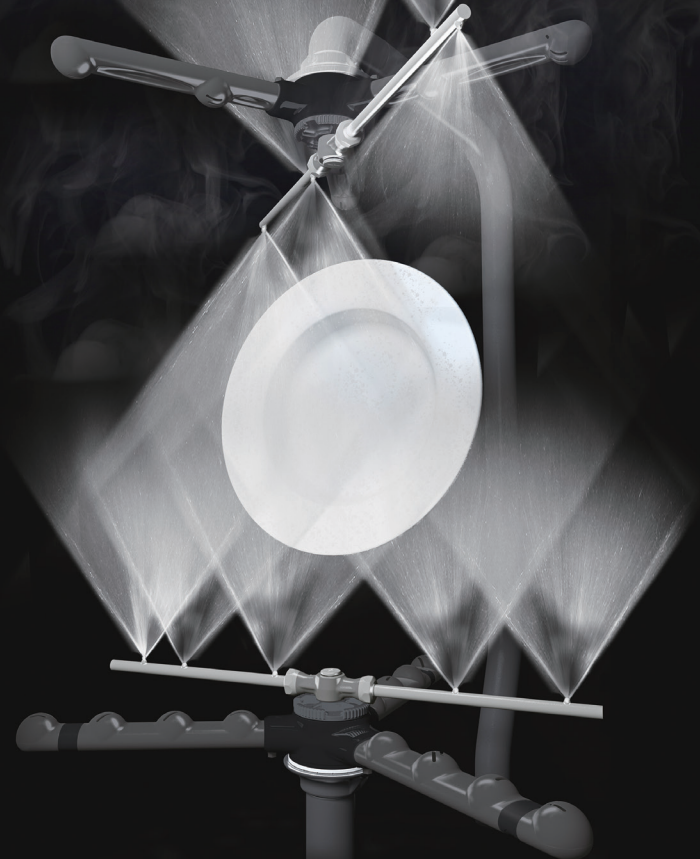

ENVIRONMENTALLY FRIENDLY

Japan designed original rinsing nozzles reduce the water consumption and enable wash away detergent thoroughly with less water consumption.

EASY TO USE TOUCH PANEL

User friendly touch control panel follows washing steps easily with colored and dynamic graphics. Detergent / Rinse aid time is adjustable from touch control panel.

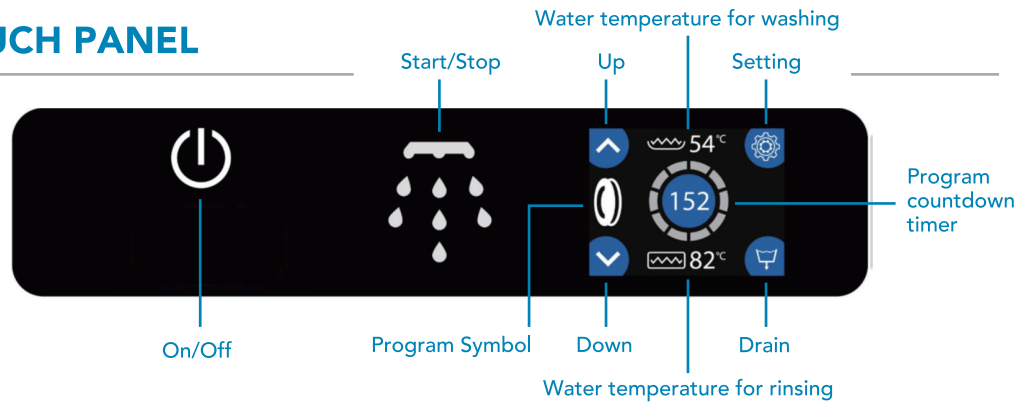

HYGIENIC DESIGN

Stainless steel and seamless integral construction washing tank with round corners keeps the machine clean and hygienic.



Designed by Hoshizaki Japan, the slanted ceiling ensures perfect cleaning result and hygiene by preventing water drops after washing.

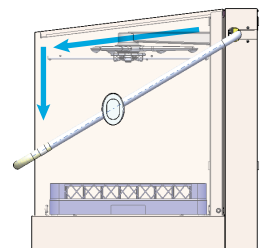

HOOD TYPE DISHWASHER HW-600B3

FRONT

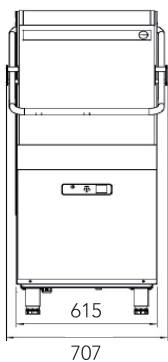

RIGHT SIDE

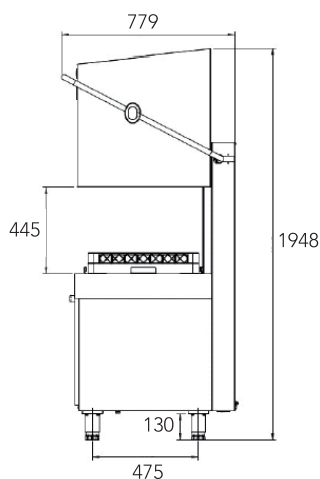
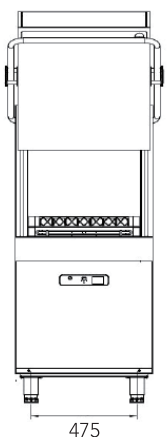
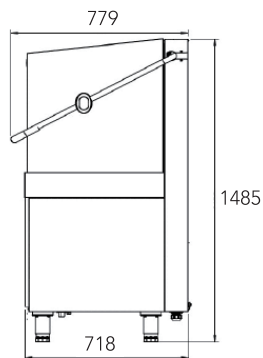

Code	071T.1111AH.GB
Model Name	HW-600B3 PDRT
Power Supply ※	3 ph / 380 - 415 V / 60Hz
Electric Consumption	9.7 - 11.5 kW
Washing Heat Power	1.8 - 2.2 kW
Rinsing Heat Power	9.0 - 10.8 kW
Rack Dimensions	500 x 500 mm
Number of Programmes	5
Washing Capacity (Rack / Hour)	69 / 35 / 27 / 23 / 18
Washing Water Temp.	55 - 60 °C
Rinsing Water Temp.	80 - 85 °C
Water Consumption	2.3 L
Washing / Boiler Tank Capacity	22 L / 7 L
Max. Noise	67 dBA
Loading Height	445 mm
Outside Dimensions / Weight	707(W) x 779(D) x 1485(H) mm / 110 kg
Package / Weight	725(W) x 795(D) x 1638(H) mm / 120 kg
Water Inlet Connection	3 / 4 inch
Water Inlet Pressure / Temp.	2 - 4 Bar / max 50 °C
Drain Water Discharge Connection	3 / 4 inch (Ø28 mm)
Accessories	<ul style="list-style-type: none"> - Electrical Connection Cable - Flexible Water Supply and Drain Hose - 3 Racks (Plate, Glass and Cutlery) - Detergent & Rinse Aid Dispenser - Drain Pump

※Single phase is also available



HOSHIZAKI