



# HOSHIZAKI

## CERTIFICATION



HACCP International



ISO9001



Compliant with IEC60335-2-89 Standard

## FT-186MC-S-ML

### UNDERCOUNTER PILLAR-LESS FREEZER



## Key Features



Lower running cost



Powerful cooling performance

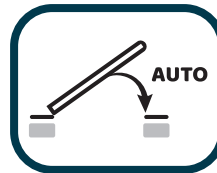

Self Closing Door



Removal door gaskets



Round Interior Corners



Large and clear display



Drainage-Free Design



LED lighting



# Dimensions & Specifications

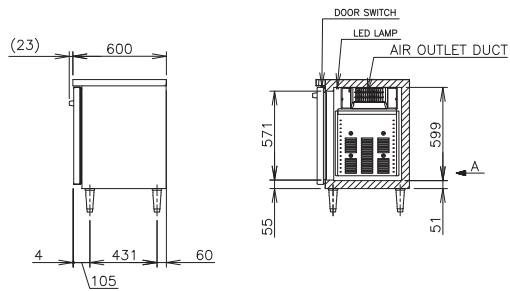
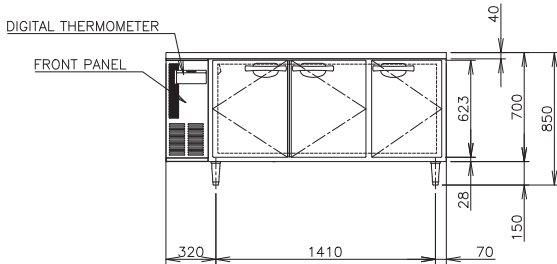
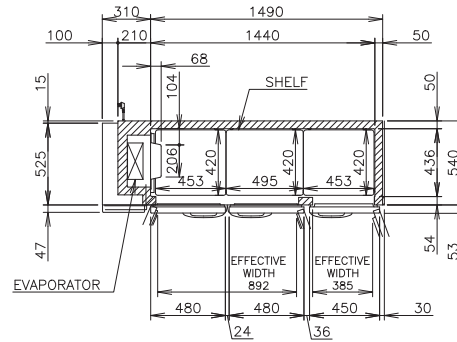
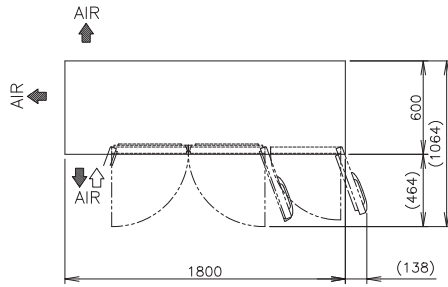
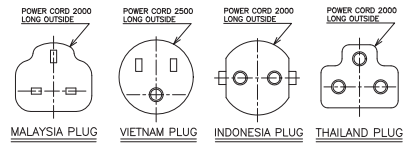
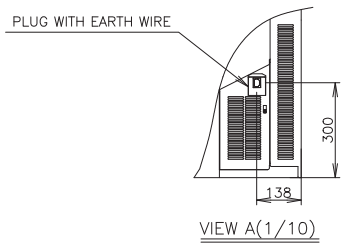

| MODEL                | FT-186MC-S-ML   |
|----------------------|---|
| POWER SUPPLY         | 1 Phase 220-240V 50Hz Capacity: 0.75kVA (3.50A)                 |
| ELECTRIC CONSUMPTION | 300W  |
| TEMPERATURE CONTROL  | -25 to -7°C   |
| STORAGE CAPACITY     | 409L  |
| WEIGHT               | Net: 100kg (Gross: Approx. 112kg)                               |
| OUTSIDE DIMENSIONS   | 1800mm(W)× 600mm(D)×850(-880)mm(H)                              |
| PACKAGE              | Carton: 1865mm(W)×680mm(D)×845mm(H)                             |
| NUMBER OF SHELVES    | 6   |
| REFRIGERANT          | R290  |
| OPERATING CONDITIONS | Ambient Temperature: 5 - 38°C, Voltage Range: Rated Voltage ±6% |



# HOSHIZAKI

**HOSHIZAKI VIETNAM CORPORATION**

168/14 Nguyen Gia Tri, Thanh My Tay Ward, Ho Chi Minh City  
Vietnam 760000

TEL +84 0 916 161 346 <https://hoshizaki-sea.com/>

