



# HOSHIZAKI

## CERTIFICATION



HACCP International



ISO9001



Compliant with IEC60335-2-89 Standard

## FT-188MC-S-ML

### UNDERCOUNTER PILLAR-LESS FREEZER



### Key Features



Lower running cost



Powerful cooling performance



Self Closing Door



Removal door gaskets

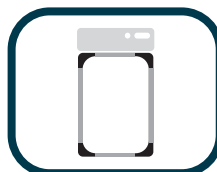

Round Interior Corners



Large and clear display



Drainage-Free Design



LED lighting



## Dimensions & Specifications

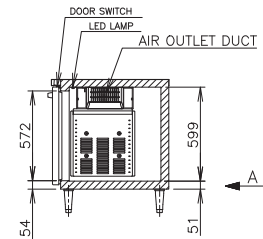
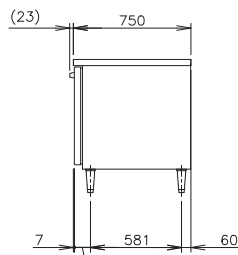
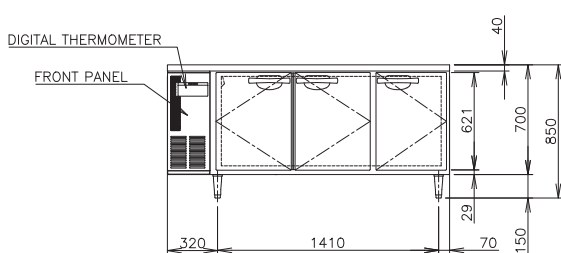
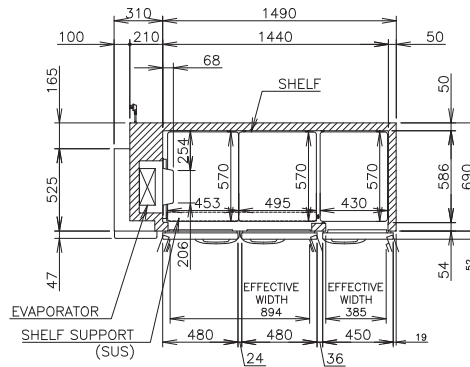
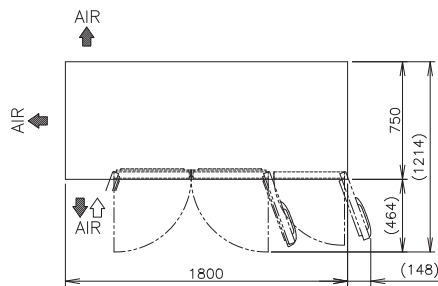
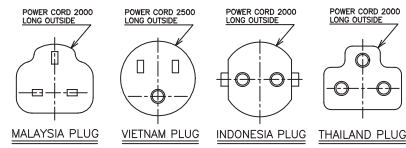
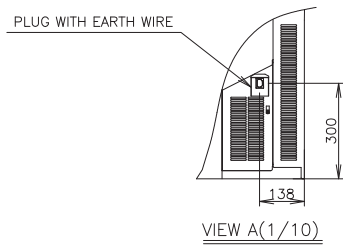

<b>MODEL</b>	<b>FT-188MC-S-ML</b>
<b>POWER SUPPLY</b>	1 Phase 220-240V 50Hz Capacity: 0.75kVA (3.50A)
<b>ELECTRIC CONSUMPTION</b>	300W
<b>TEMPERATURE CONTROL</b>	-25 to -7°C
<b>STORAGE CAPACITY</b>	538L
<b>WEIGHT</b>	Net: 111kg (Gross: Approx. 123kg)
<b>OUTSIDE DIMENSIONS</b>	1800mm(W)× 750mm(D)×850(-880)mm(H)
<b>PACKAGE</b>	Carton: 1865mm(W)×830mm(D)×845mm(H)
<b>NUMBER OF SHELVES</b>	6
<b>REFRIGERANT</b>	R290
<b>OPERATING CONDITIONS</b>	Ambient Temperature: 5 - 38°C, Voltage Range: Rated Voltage ±6%



# HOSHIZAKI

**HOSHIZAKI MALAYSIA SDN. BHD.**

No. 12, Jalan Penyajak U1/45B. Hicom-Glenmarie Industrial Park, 40150 Shah Alam, Selangor

TEL (+60) 3 5569 8023 <https://hoshizaki.com.my/>

