



HOSHIZAKI

CERTIFICATION



HACCP International



ISO9001



Compliant with IEC60335-2-89 Standard

FT-188MC-S-ML

UNDERCOUNTER PILLAR-LESS FREEZER



Key Features



Lower running cost



Powerful cooling performance



Self Closing Door



Removal door gaskets

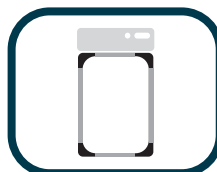

Round Interior Corners



Large and clear display



Drainage-Free Design



LED lighting



Dimensions & Specifications

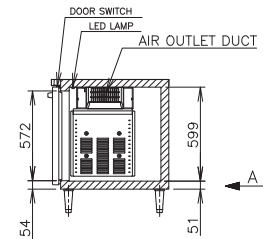
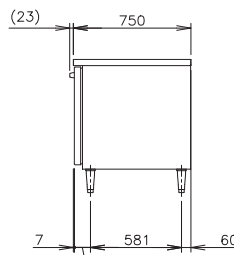
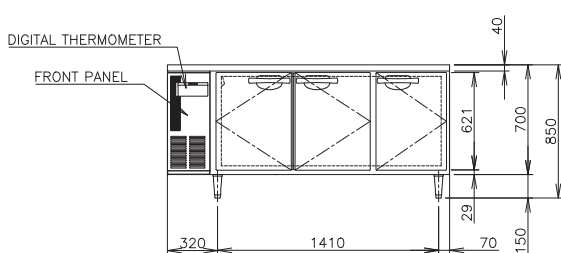
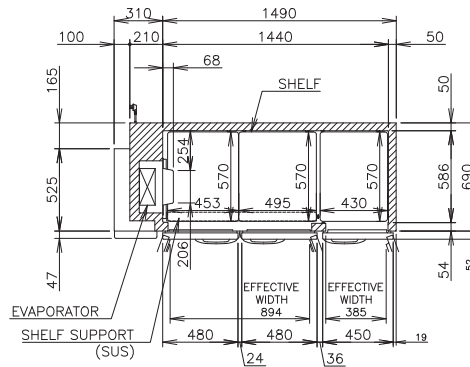
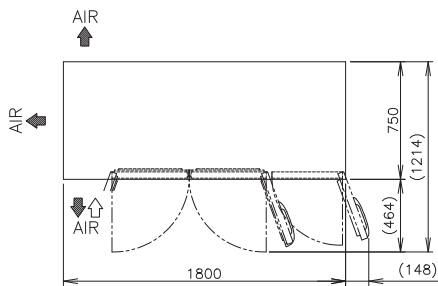
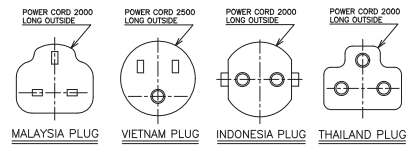
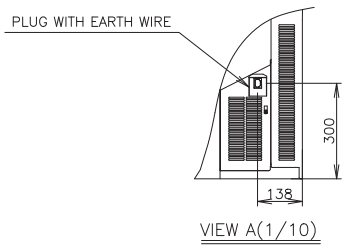

MODEL	FT-188MC-S-ML
POWER SUPPLY	1 Phase 220-240V 50Hz Capacity: 0.75kVA (3.50A)
ELECTRIC CONSUMPTION	300W
TEMPERATURE CONTROL	-25 to -7°C
STORAGE CAPACITY	538L
WEIGHT	Net: 111kg (Gross: Approx. 123kg)
OUTSIDE DIMENSIONS	1800mm(W)× 750mm(D)×850(-880)mm(H)
PACKAGE	Carton: 1865mm(W)×830mm(D)×845mm(H)
NUMBER OF SHELVES	6
REFRIGERANT	R290
OPERATING CONDITIONS	Ambient Temperature: 5 - 38°C, Voltage Range: Rated Voltage ±6%



HOSHIZAKI

HOSHIZAKI (THAILAND) LIMITED

No. 99 CP Tower North Park building 9th Floor, Zone D1 Soi
 Ngamwongwan 47 Intersection 42, Thung Song Hong
 Subdistrict, Lak Si District, Bangkok 10210 Thailand
 TEL +66 2 005 9980 FAX +66 2 516 2646
<https://hoshizaki-sea.com/>

