



# HOSHIZAKI

## CERTIFICATION



HACCP International



ISO9001



Compliant with IEC60335-2-89 Standard

## HR-78MC-SG

### UPRIGHT GLASS DOOR REFRIGERATOR



### Key Features



Lower running cost



Powerful cooling performance



Self Closing Door



Removal door gaskets



Food Guard Shelf



Round Interior Corners



Large and clear display



Drainage-Free Design



LED lighting



## Dimensions & Specifications

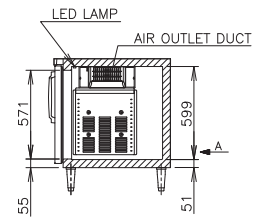
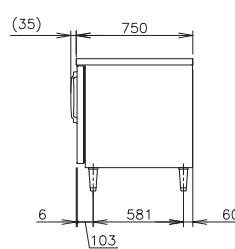
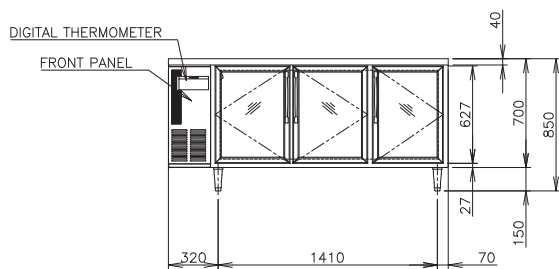
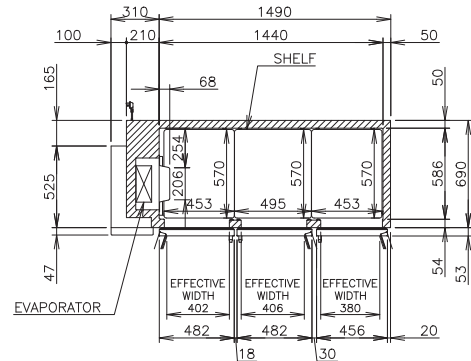
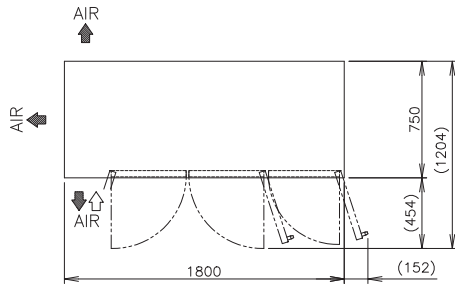
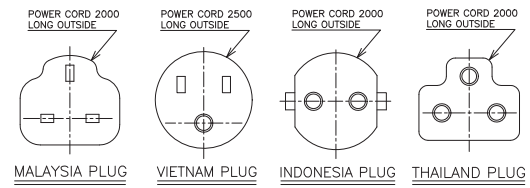
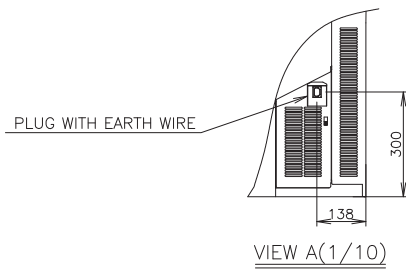

MODEL	HR-78MC-SG
POWER SUPPLY	1 Phase 220-240V 50Hz Capacity: 0.63kVA (2.90A)
ELECTRIC CONSUMPTION	416W
TEMPERATURE CONTROL	-2 to 12°C
STORAGE CAPACITY	567L
WEIGHT	Net: 112kg (Gross: Approx. 134kg)
OUTSIDE DIMENSIONS	700mm(W)× 800mm(D)×2050(-2080)mm(H)
PACKAGE	Carton(Wooden Pallet): 760mm(W)×900mm(D)×2075mm(H)
NUMBER OF SHELVES	4
REFRIGERANT	R290
OPERATING CONDITIONS	Ambient Temperature: 5 - 38°C, Voltage Range: Rated Voltage ±6%



# HOSHIZAKI

## HOSHIZAKI (THAILAND) LIMITED

No. 99 CP Tower North Park building 9th Floor, Zone D1 Soi  
 Ngamwongwan 47 Intersection 42, Thung Song Hong  
 Subdistrict, Lak Si District, Bangkok 10210 Thailand  
 TEL +66 2 005 9980 FAX +66 2 516 2646  
<https://hoshizaki-sea.com/>

