



# HOSHIZAKI

## CERTIFICATION



HACCP International



ISO9001



Compliant with IEC60335-2-89 Standard

## RFT-156MC-S UNDERCOUNTER DUAL TEMP.



### Key Features



Lower running cost



Powerful cooling performance



Self Closing Door



Removal door gaskets



Food Guard Shelf

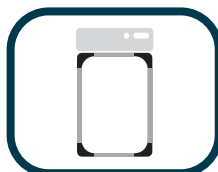

Round Interior Corners



Large and clear display



Drainage-Free Design



LED lighting



# Dimensions & Specifications

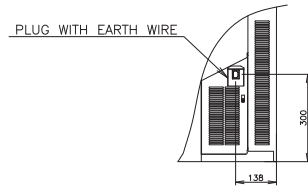

VIEW A(1/10)

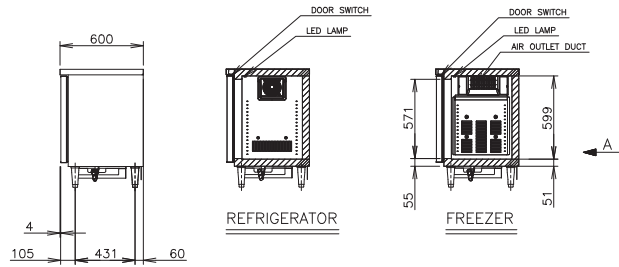
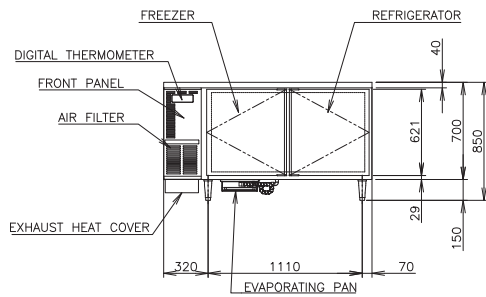
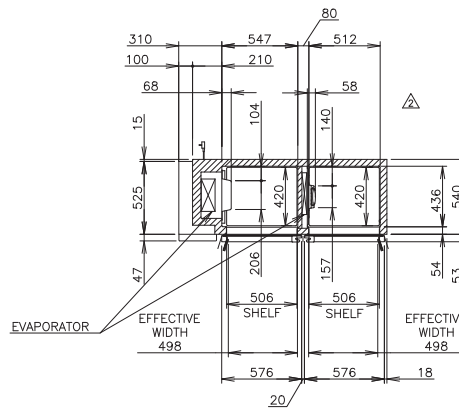
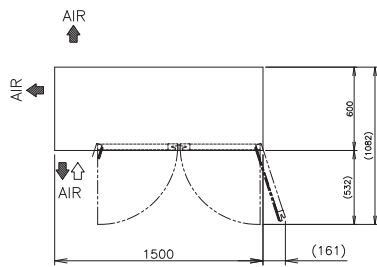
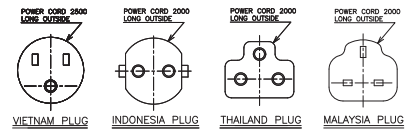

MODEL	RFT-156MC-S
POWER SUPPLY	1 Phase 220-240V 50Hz Capacity: 0.75kVA (3.50A)
ELECTRIC CONSUMPTION	485W
TEMPERATURE CONTROL	Refrigerator: -6 to 12°C, Freezer: -25 to -7°C
STORAGE CAPACITY	287L (Refrigerator: 136L, Freezer: 151L)
WEIGHT	Net: 94kg (Gross: Approx. 112kg)
OUTSIDE DIMENSIONS	1500mm(W)× 600mm(D)×850(-880)mm(H)
PACKAGE	Carton: 1565mm(W)×680mm(D)×845mm(H)
NUMBER OF SHELVES	4
REFRIGERANT	R290
OPERATING CONDITIONS	Ambient Temperature: 5 - 38°C, Voltage Range: Rated Voltage ±6%



# HOSHIZAKI

**HOSHIZAKI VIETNAM CORPORATION**

168/14 Nguyen Gia Tri, Thanh My Tay Ward, Ho Chi Minh City  
Vietnam 760000

TEL +84 0 916 161 346 <https://hoshizaki-sea.com/>

