



HOSHIZAKI

CERTIFICATION



HACCP International



ISO9001



Compliant with
IEC60335-2-89 Standard

RT-126MC-SG

UNDERCOUNTER SWING GLASS DOOR REFRIGERATOR



Key Features



Lower running cost



Powerful cooling
performance

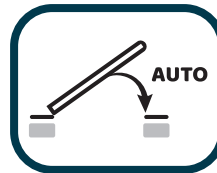

Self Closing Door



Removal door gaskets



Round Interior Corners



Large and clear display



Drainage-Free Design



LED lighting



Dimensions & Specifications

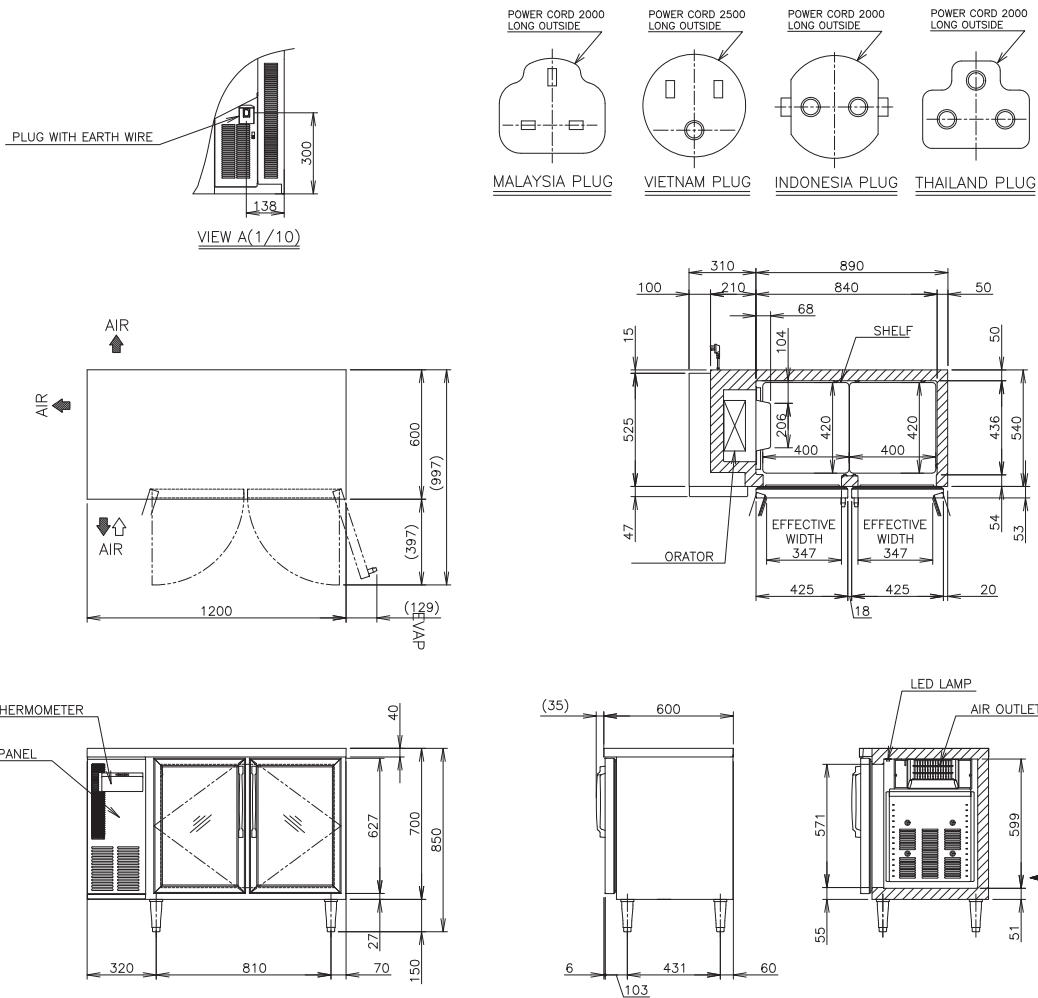

MODEL	RT-126MC-SG
POWER SUPPLY	1 Phase 220-240V 50Hz Capacity: 0.41kVA (1.86A)
ELECTRIC CONSUMPTION	250W
TEMPERATURE CONTROL	-2 to 12°C
STORAGE CAPACITY	234L
WEIGHT	Net: 81kg (Gross: Approx. 93kg)
OUTSIDE DIMENSIONS	1200mm(W)× 600mm(D)×850(-880)mm(H)
PACKAGE	Carton: 1265mm(W)×680mm(D)×845mm(H)
NUMBER OF SHELVES	4
REFRIGERANT	R290
OPERATING CONDITIONS	Ambient Temperature: 5 - 38°C, Voltage Range: Rated Voltage ±6%



HOSHIZAKI

HOSHIZAKI VIETNAM CORPORATION

168/14 Nguyen Gia Tri, Thanh My Tay Ward, Ho Chi Minh City
Vietnam 760000

TEL +84 0 916 161 346 <https://hoshizaki-sea.com/>

