



HOSHIZAKI

CERTIFICATION



HACCP International



ISO9001



Compliant with
IEC60335-2-89 Standard

RT-128MC-SG

UNDERCOUNTER SWING GLASS DOOR REFRIGERATOR



Key Features



Lower running cost



Powerful cooling
performance



Self Closing Door



Removal door gaskets

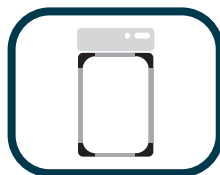

Round Interior Corners



Large and clear display



Drainage-Free Design



LED lighting



Dimensions & Specifications

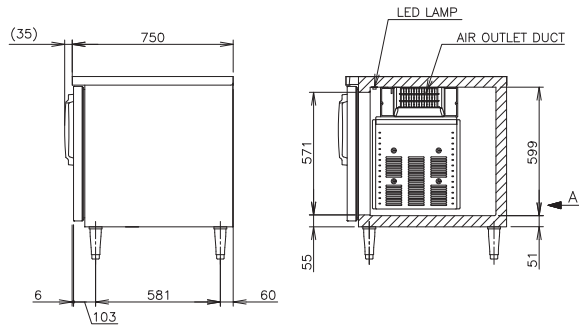
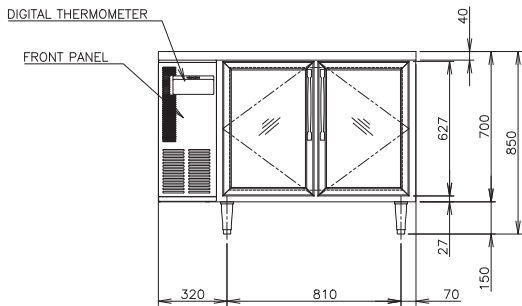
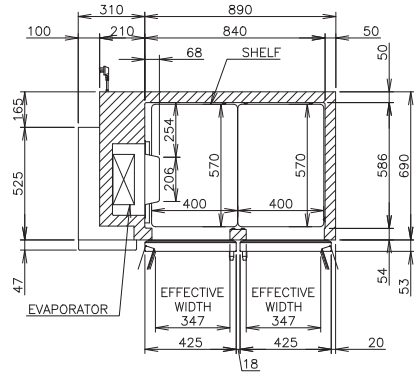
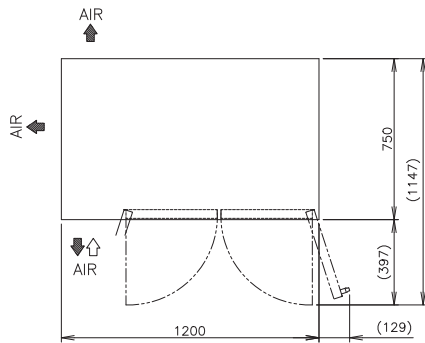
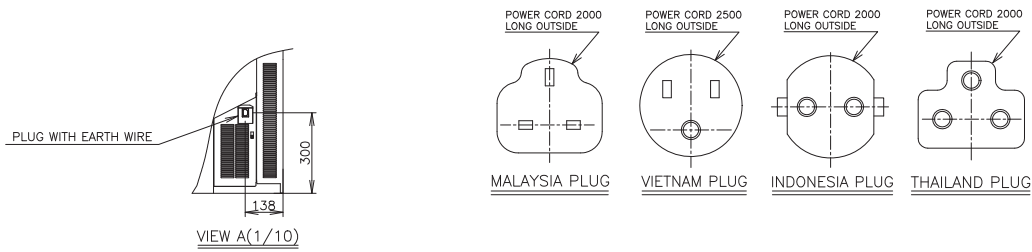

MODEL	RT-128MC-SG
POWER SUPPLY	1 Phase 220-240V 50Hz Capacity: 0.41kVA (1.86A)
ELECTRIC CONSUMPTION	250W
TEMPERATURE CONTROL	-2 to 12°C
STORAGE CAPACITY	310L
WEIGHT	Net: 89kg (Gross: Approx. 101kg)
OUTSIDE DIMENSIONS	1200mm(W)× 750mm(D)×850(-880)mm(H)
PACKAGE	Carton: 1265mm(W)×830mm(D)×845mm(H)
NUMBER OF SHELVES	4
REFRIGERANT	R290
OPERATING CONDITIONS	Ambient Temperature: 5 - 38°C, Voltage Range: Rated Voltage ±6%



HOSHIZAKI

HOSHIZAKI MALAYSIA SDN. BHD.

No. 12, Jalan Penyajak U1/45B. Hicom-Glenmarie Industrial Park, 40150 Shah Alam, Selangor

TEL (+60) 3 5569 8023 <https://hoshizaki.com.my/>

