



# HOSHIZAKI

## CERTIFICATION



HACCP International



ISO9001



Compliant with IEC60335-2-89 Standard

## RT-186MC-SG

### UNDERCOUNTER SWING GLASS DOOR REFRIGERATOR



### Key Features



Lower running cost

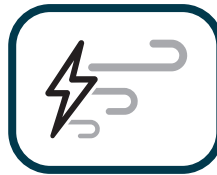

Powerful cooling performance

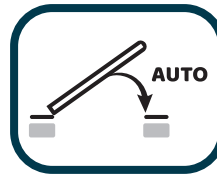

Self Closing Door



Removal door gaskets



Round Interior Corners



Large and clear display

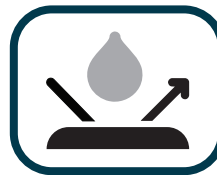

Drainage-Free Design



LED lighting



# Dimensions & Specifications

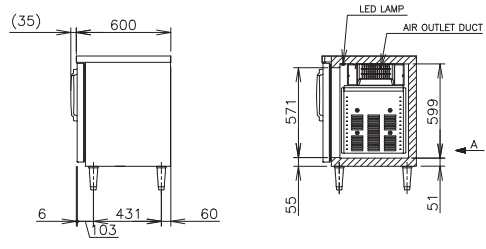
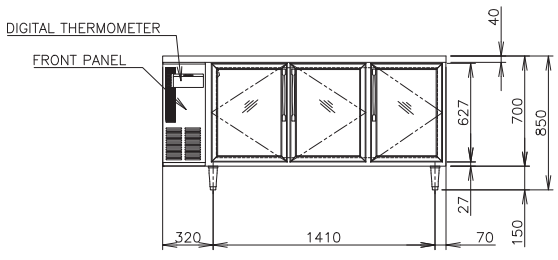
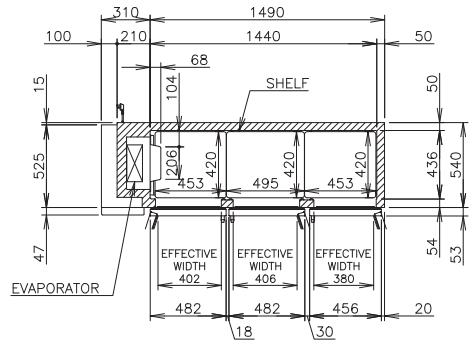
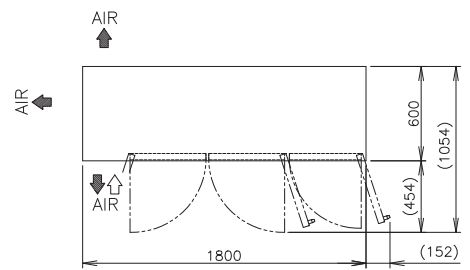
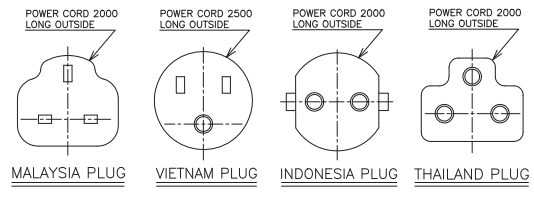
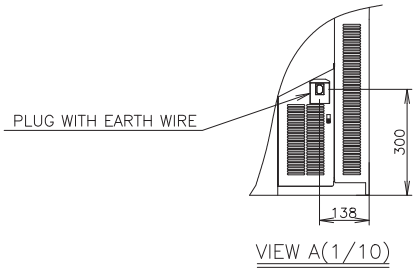

<b>MODEL</b>	<b>RT-186MC-SG</b>
<b>POWER SUPPLY</b>	1 Phase 220-240V 50Hz Capacity: 0.41kVA (1.86A)
<b>ELECTRIC CONSUMPTION</b>	290W
<b>TEMPERATURE CONTROL</b>	-2 to 12°C
<b>STORAGE CAPACITY</b>	407L
<b>WEIGHT</b>	Net: 110kg (Gross: Approx. 122kg)
<b>OUTSIDE DIMENSIONS</b>	1800mm(W)× 600mm(D)×850(-880)mm(H)
<b>PACKAGE</b>	Carton: 1865mm(W)×680mm(D)×845mm(H)
<b>NUMBER OF SHELVES</b>	6
<b>REFRIGERANT</b>	R290
<b>OPERATING CONDITIONS</b>	Ambient Temperature: 5 - 38°C, Voltage Range: Rated Voltage ±6%



# HOSHIZAKI

**HOSHIZAKI VIETNAM CORPORATION**

168/14 Nguyen Gia Tri, Thanh My Tay Ward, Ho Chi Minh City  
 Vietnam 760000  
 TEL +84 0 916 161 346 <https://hoshizaki-sea.com/>

