



HOSHIZAKI

CERTIFICATION



HACCP International



ISO9001



Compliant with IEC60335-2-89 Standard

RT-188MC-SG

UNDERCOUNTER SWING GLASS DOOR REFRIGERATOR



NATURAL REFRIGERANTS



Key Features



Lower running cost

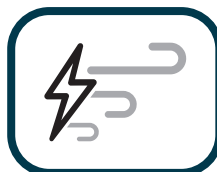

Powerful cooling performance

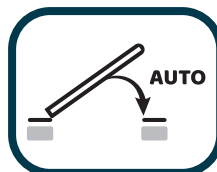

Self Closing Door

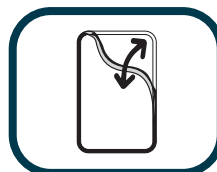

Removal door gaskets

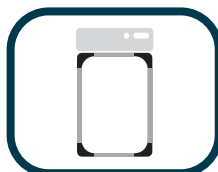

Round Interior Corners



Large and clear display



Drainage-Free Design



LED lighting



Dimensions & Specifications

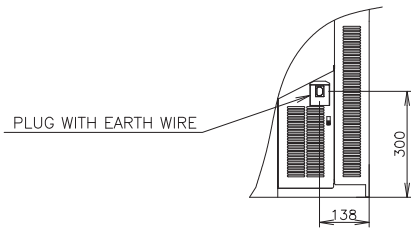

VIEW A(1/10)

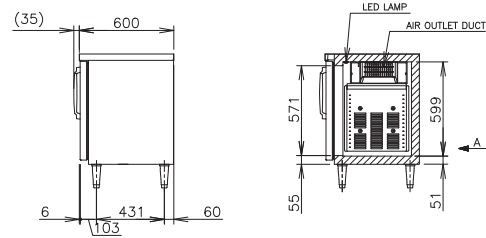
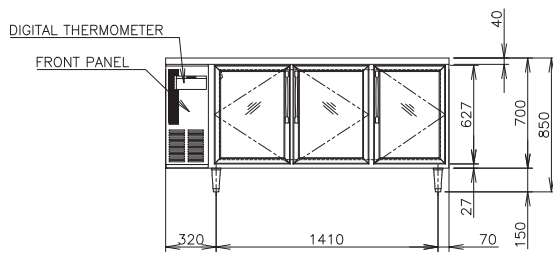
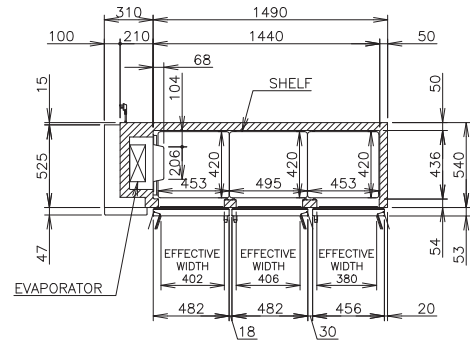
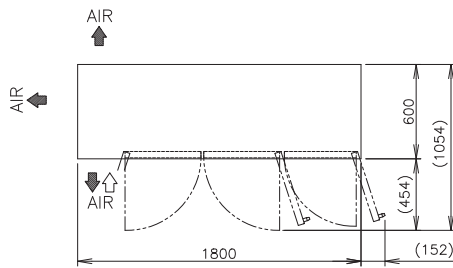
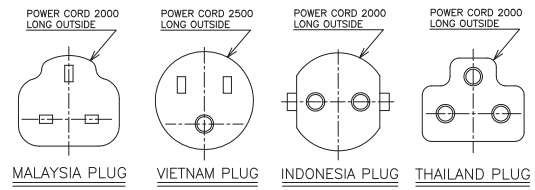

MODEL	RT-188MC-SG
POWER SUPPLY	1 Phase 220-240V 50Hz Capacity: 0.41kVA (1.86A)
ELECTRIC CONSUMPTION	290W
TEMPERATURE CONTROL	-2 to 12°C
STORAGE CAPACITY	536L
WEIGHT	Net: 125kg (Gross: Approx. 137kg)
OUTSIDE DIMENSIONS	1800mm(W)× 750mm(D)×850(-880)mm(H)
PACKAGE	Carton: 1865mm(W)×830mm(D)×845mm(H)
NUMBER OF SHELVES	6
REFRIGERANT	R290
OPERATING CONDITIONS	Ambient Temperature: 5 - 38°C, Voltage Range: Rated Voltage ±6%



HOSHIZAKI

HOSHIZAKI MALAYSIA SDN. BHD.

No. 12, Jalan Penyajak U1/45B. Hicom-Glenmarie Industrial Park, 40150 Shah Alam, Selangor

TEL (+60) 3 5569 8023 <https://hoshizaki.com.my/>

